

ASTRA

***9417CW Installation
and
User Guide***



Meridian 9417CW Important Tips

- *Wait for at least two rings to allow the phone to identify a caller and display the caller's name and/or number. You will have to subscribe to a Calling Line Identification service to take advantage of this feature.*
- *If the Handsfree mode (speakerphone) is not working, ensure that you have the Headset option disabled in the options list.*
- *The Meridian 9417CW is able to make and receive calls even during a power failure. Features such as the display and memory keys will not work without power.*
- *To call back local calls from the Callers List, be sure to remove the area code.*
- *To use the Call Waiting Identification feature, you must subscribe to a Call Waiting Identification service from your local telephone company.*
- *Some memory keys may be factory pre-programmed, and cannot be programmed by the user.*
- *Remember that there is a 24 digit limit on the length of numbers and a 16 character limit on names.*
- *To prevent wobbling, route cords through the telephone stand as outlined in the Installation section of this guide.*
- *You can answer Call Waiting by pressing .*

Table of Contents

Introduction	1	Finding items in the Directory	17
Key Descriptions	2	Editing in the Directory	17
The Setup and Options lists	3	Deleting items from the Directory	18
Basic Installation	4	Callers List	19
Connecting the handset cord	4	Using the Callers List	19
Connecting the power adaptor	4	Setting up the Callers List	19
Connecting the Line Cord	4	Setting the List Mode	19
Connecting an optional fax machine or modem	5	Finding an item in the Callers List	20
Checking your telephone	6	Making a call from the Callers List	20
Desk Mounting	6	Editing in the Callers List	21
Optional Wall Mounting	6	Saving Callers List numbers to the Directory or a Memory key	21
Adjusting the Display	6	Deleting from the Callers List	22
The Set Options Key	6	Memory keys	22
Basic Features	7	Saving numbers and names into memory keys	22
Making a call	7	Saving from the display into memory keys	23
Answering a call	7	Saving an active call into a memory key	23
Putting a call on hold	7	Labeling the memory keys	23
Switching between two lines	8	Making calls from memory keys	24
Making a Conference call	8	Editing memory keys	24
Extension in Use	8	Deleting memory keys	24
Making a Handsfree call	8	Saving features in memory keys	25
Putting a call on mute	9	Using feature keys	25
Using the Redial List	9	Saving a feature and light in memory keys	25
Call Waiting Identification	10	Using FeatureLight keys	26
Super Call Waiting Identification	10	Advanced Features	27
SuperFlash	11	Adding a timer key	27
Turning the display of Call Waiting Identification on or off	12	Using the Call Timer	27
Changing the display language	12	Deleting a timer key	27
Setting the date and time	13	Adding a page key	28
Turning the ringer on and off	13	Using the page	28
Setting ring tone and ringer volume	14	Deleting a page key	29
Controlling the ringer volume	14	Installing the page lines	29
Controlling the handset volume	14	Selecting the dial pad mode	30
Controlling the speaker volume	14	Entering area codes	30
Changing the prime line	14	Entering Dialing Restrictions	31
Directory	15	The Security Numbers Feature	32
Saving numbers and names to the Directory	15	The Fax Switch	33
Saving active call into the Directory	15	Incoming Calls	33
Saving a memory key entry to the Directory	16	Outgoing Calls	33
Entering Names	16	Setting the Fax Switch	33
Making a call from the Directory	17	Copying the Directory to another 9417CW telephone	34

Table of Contents

Using a headset	34
Selecting the answer mode	35
Extension in use	35
Display messages and lights	36
The Callers List screen	36
Knowing when you have a message	36
Clear Message Waiting	36
Clear the Check Line Cord Message	37
General display messages	37
Callers List display messages	38
Learning about the lights	39
Set indicator light messages	39
Line and Handsfree indicator light messages	39
Viewing multiple display and light messages	39
Troubleshooting	40
Index	

Introduction

Thank you for purchasing 9417CW telephone. We think you'll find it's full of exciting features. With a personal Directory and a Callers list, your new two-line telephone is designed to take full advantage of the latest services offered by your local telephone company.

When you subscribe to services such as Calling Line Identification and Call Waiting Identification[†] through your local telephone company, your 9417CW will show you all the caller information you'll need on its three-line back-lit display. For example, before you even answer a call you'll know who is calling, even if it's a Call Waiting call. And Call Waiting Identification information can appear on two telephone extensions at the same time so that someone at either extension can initiate the switch to a Call Waiting call. Your telephone will also tell you how many new callers you have.

You can set up a personal Directory in which you can enter up to 100 names and numbers, and your Callers List will log up to 100 incoming calls. The Options List and Setup List make it easy for you to personalize your telephone, and the back-lit three-line display provides walk-through prompting that makes all of the many features and options even easier to customize. Please read on for more information on the many features of your 9417CW.

[†] The names of these services may vary from area to area.

Key Descriptions

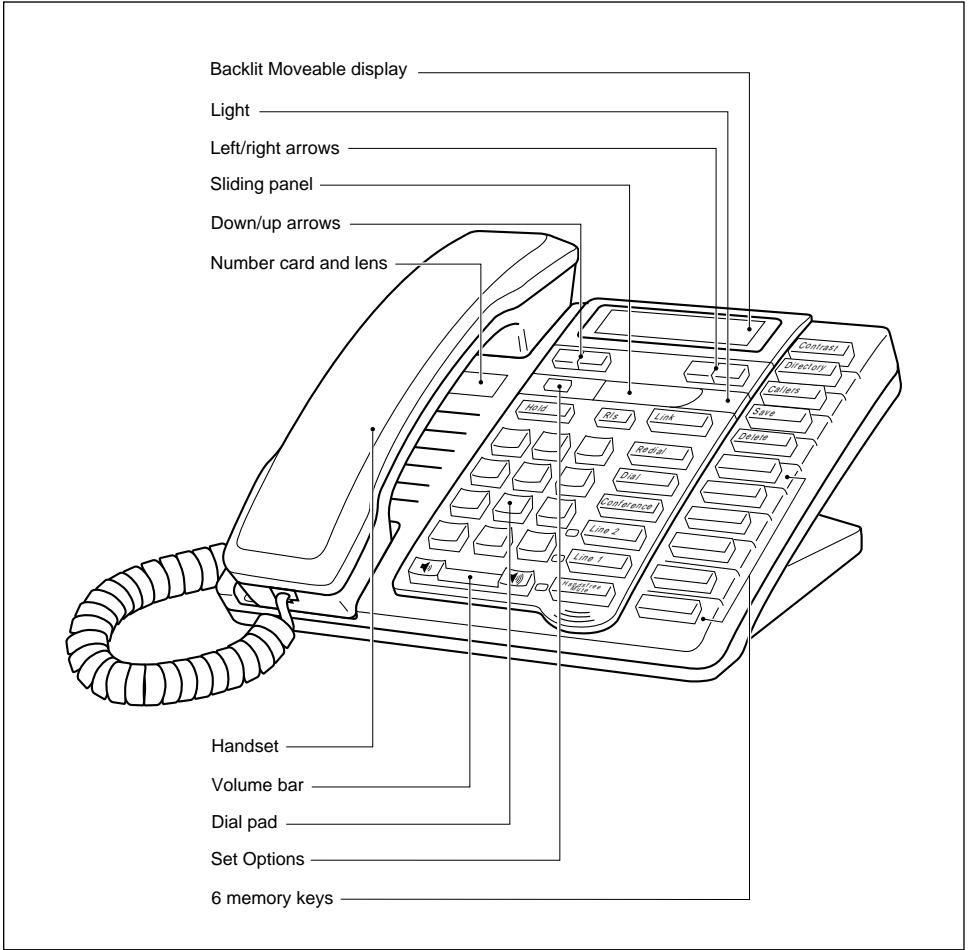

Contrast

Cycles through eight settings to adjust the display contrast.

Directory

Allows you to store and access up to 100 numbers and names.

Callers

Allows you to access a list of people who have called.

Save

Stores numbers and names in the Directory and in memory keys.

Delete

Allows you to erase memory keys, the Redial list, and delete items in the Directory and Callers List.

↓ ↑











Allows you to move up and down any list such as the Set Options, Directory, Callers List, or Redial List.

←

Allows you to backspace and erase when predialing and when adding or changing numbers and names in the Directory or in memory keys.

→

Adds a space when entering names in the Directory or in memory keys, and allows you to view status messages on the display.

-  Puts the call on hold.
-  Always hangs up a call. Also lets you leave any list such as the Setup List, Options List, Callers List, Redial List or Directory.
-  Allows you to access network features such as Call Waiting. Link is also referred to as Flash.
-  Allows you to access a list of the last ten numbers you dialed.
-  Selects your prime line and dials any displayed number. Puts you on Handsfree if you haven't lifted the handset.
-  Joins the calls on the two line keys together.
-  Selects Line 1 or Line 2 and turns on Handsfree if you have not picked up the handset. Dials any number on the display.
-  Activates the speaker and microphone so you can listen and talk without lifting the handset.
-  Allows you to adjust the receiver, speaker, and ringer volume.
-  Memory keys store numbers, names, and features.
-  The unlabeled Set Options key is hidden under the sliding panel. This key gives you access to two lists of options, the Setup List and the Options List. The Setup List contains ten options that customize the basic setup of your telephone. The Options List contains nine options that personalize the features of your telephone. The table below lists the page numbers where these options are described.

The Setup and Options lists

Setup List	page	Options List	page
0. Change display language	12	0. Set the date and time	13
1. Enable headset	34	1. Select the ring tone	14
2. Enter dialing restrictions	31	2. Select the dial pad mode	30
3. Enter area codes	30	3. Clear message waiting	36
4. Change answer mode	35	4. Change the Callers List	19
5. Set prime line	14	5. Change the list mode	19
6. Add a timer key	27	6. Change the Fax Switch	33
7. Add a page key	28	7. Data transfer	34
8. Security Feature	32	8. Call Waiting ID Display	12
9. Check line cord	37		

Basic Installation

Follow the instructions below to install your 9417CW telephone.

Connecting the handset cord

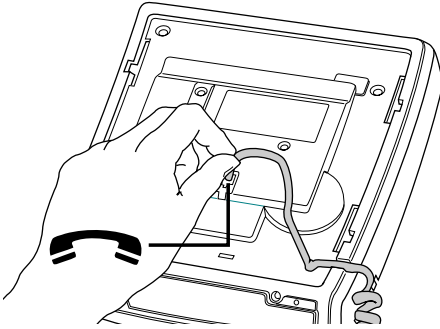

Attach one end of the handset cord to the handset and the other end to the handset jack.

Connecting the power adaptor

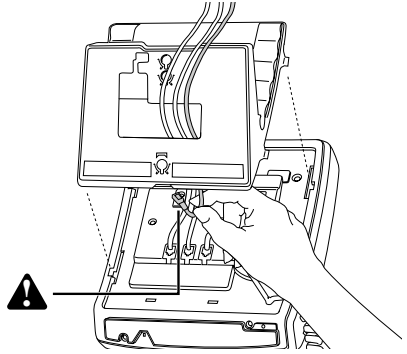



Attach the power adaptor to the base of the telephone where the warning symbol is marked. Connect the power adaptor into the closest electrical outlet.

Connecting the Line Cord when†...

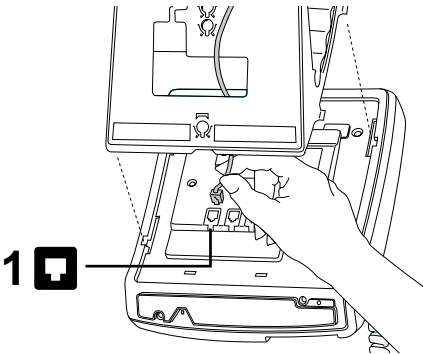

...lines 1 and 2 are on the same line cord

...lines 1 and 2 are on different line cords

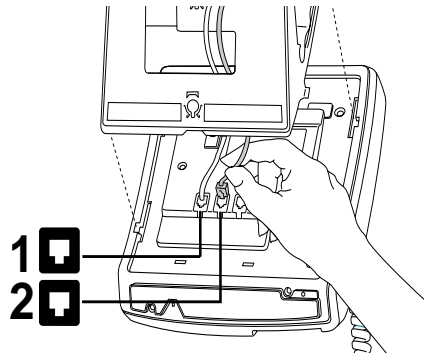

Insert the line cord in jack 1, as shown by 1 . Insert the other end of the line cord into the wall jack.



Insert the first line cord in jack 1 as shown by 1 . Insert the second line cord in jack 2 as shown by 2 . Insert the other ends of the line cords into the wall jacks.

†To determine whether you have two lines on one telephone cord, attach one end of the line cord to jack number 1 and the other end of the line cord to the wall jack. Then plug in the power adaptor and read the display. (If the display prompts you to select a language, choose your language of choice.) If Lines 1 and 2 are on the same line cord, the time and date are shown. If Lines 1 and 2 are on separate line cords, Check line cord appears on the first line of the display and Line 2 appears on the second line of the display. If you want Line 1 and Line 2 on the same line cord, contact your telephone company.

Connecting an optional fax machine or modem

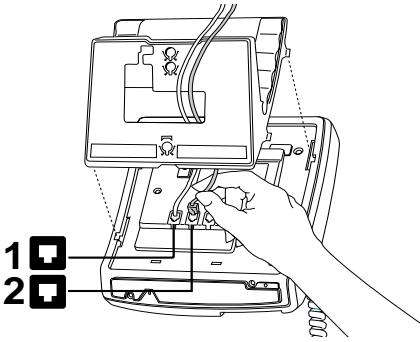

Attach the line cord to jack number 2 and the other end to the modem or fax machine. This line cord is not supplied with the telephone.



To avoid potential electrical shock hazard to personnel or damage to the telephone, use **only** the manufacturer-supplied equipment and installation procedures. Specifically, use only 4 conductor modular teledapt plug/cords with this product, and an AC transformer that is CSA/UL or CSA-NRTL/C approved Class 2 level C, rated as follows: **For North American Markets mains nominal AC voltage 110-117V**, Input: 110/117VAC, 50/60Hz, 10W and Output: 16VAC 250mA. **For International Markets mains nominal AC voltage 220-240V**, Input: 220/240VAC, 50/60Hz, 10W and Output: 16VAC 250mA. Substitution of non-approved equipment will void the Aastra Telecom Inc., warranty. For more information about installation and safety concerns, call 1-800-574-1611.

Checking your telephone

When you plug in your 9417CW, you may see a message asking you to make a language selection. Follow the directions on the display to select one of the languages.

Your telephone also runs a test to ensure that the line cords are connected properly. If the test fails, the display identifies which line is not connected. Make sure that all connections are fastened securely.

Desk Mounting

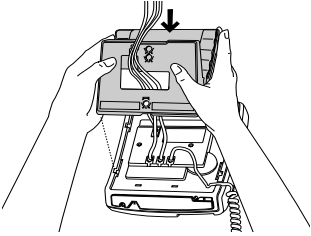

Lower the stand into the slots on the base of the telephone, as shown above.

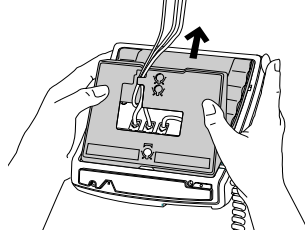

Slide the stand back until it clicks into the locked position.

Optional Wall Mounting[†]

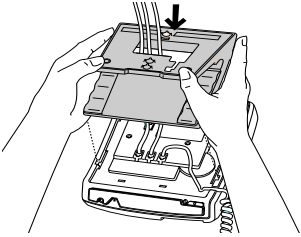

Lower the stand into the slots on the base of the telephone, as shown above.

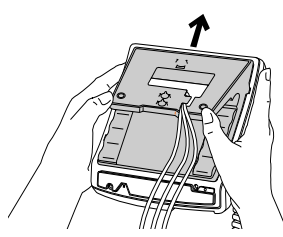

Slide the stand back until it clicks into the locked position.

Adjusting the Display



Place your 9417CW on a table or hang it on a wall, then adjust the display.

The Set Options Key

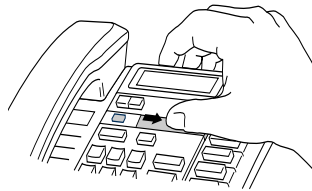

Move the sliding panel over to the right to reveal the Set Options key.

[†]We recommend that you use a wall mounting plate which is available through your telephone company. If you are going to wall mount your 9417CW, use a 20 cm (8") line cord (not supplied).



Note: The Ringer Equivalence Number (REN) is 1.4B for the 9417CW telephone. Please see the base of your telephone or the Regulations sheet for more regulatory and safety information.

Basic Features



Making a call

You can use the 9417CW to simply make a regular call, or you can predial a telephone number to ensure it is correct before it is dialed out. Follow the procedures below to make a regular or predialed call.



To make a regular call:

1. Lift the handset or press either  or .
2. Enter the number using the dial pad.

To make a predialed call:

1. Enter the number using the dial pad.
2. Lift the handset or press either ,  OR .

Note: If you have turned on the live dial pad option, you will not have to lift the handset or press any buttons after entering the number. Refer to **Selecting the dial pad mode** on page 30.

When you use ,  or lift the handset rather than using a line key to make a call, the prime line is automatically selected. The default prime line is Line 1. If you want to change the prime line to Line 2, see **Changing the prime line** on page 14.

Answering a call

To answer a call:



1. Lift the handset, press  or press the key for the line you want to answer.

Calling Line Identification information is sent from the telephone company to your 9417CW telephone between the first and second ring (if you subscribe to the Calling Line Identification service from your telephone company). Therefore, if you want the telephone number of the incoming call to appear on the display and in the Callers List, you must wait until the information appears on the display before answering the telephone.

If you lift the handset or press  when both lines are ringing, the line that was ringing first is automatically answered. To change which line is answered first, see **Selecting the answer mode** on page 35.

Putting a call on hold

To put a call on hold and take a call off hold:

1. Make or answer a call.
2. Press . The display shows that the call is on hold on line x and the line indicator light flashes.
Note: You won't lose the call if you hang up the handset.
3. To retrieve the call, press .
If you don't retrieve the call within 15 minutes, the call is automatically dropped.

Note: The 9417CW automatically releases a call on hold when a person on an extension telephone on the same line picks up the call. If you don't hang up the handset after you have put a call on hold and that call is picked up by someone at another exten-

sion, the call is taken off hold but remains connected to your telephone. If this happens, any background noise from your area will be heard by the caller and the person at the other extension.

Switching between two lines

To put a call on hold and make or answer a second call:

1. Make or answer a call on one line.
2. To make or answer a second call on the other line, press the second line key. This automatically puts the original line on hold.
3. To hold one line automatically and speak on the other, press the line keys alternately.
4. To end a call which is not on hold, press **[Ris]** or hang up.

Making a Conference call

To join two calls in a Conference:

1. Make or answer a call on one of the lines.
2. Make or answer a call on the second line.
3. Once you have callers on both lines, press **[Conference]**.

Note: You can speak privately with one particular caller by pressing that caller's line key. This automatically puts the other caller on hold. You can re-establish the conference by pressing **[Conference]**.

Extension in Use

When you are on a call and someone on an extension telephone picks up the handset, the set indicator light comes on if the person on the extension is using your line. The light remains on and the message Extension in use appears until the person at the other extension hangs up.

When another extension is using a line, the line indicator light for that line (located beside the line key) is illuminated. Line indicator lights let you know if a line is available for you to use. Also see **Extension in use** on page 35.

Making a Handsfree call

You don't have to use the handset to use your telephone. Instead, you can use Handsfree mode to place a call, or you can switch to Handsfree mode while a call is in progress.

To dial without picking up the handset:

1. Press **[Handsfree Mute]** or **[Line x]**.
2. Enter the number using the dial pad.
3. When the call is over, press **[Ris]**.







To switch to a Handsfree call:

1. Lift the handset.
2. Dial a number using the dial pad.
3. When the call is answered, press **[Handsfree Mute]**.
4. Hang up the handset.
5. When the call is over, press **[Ris]**.

Putting a call on mute

You can turn off the microphone so that the caller can't hear you but you can still hear the caller. Muting a call only works when you are in Handsfree mode.







To mute a call:





1. Press .
2. Without lifting the handset, make a call.
3. To turn off the microphone, press . You can hear your caller but your caller cannot hear you. The light beside  flashes. The display shows Microphone muted.
4. To speak to your caller, press  again. Each time you press , you turn the microphone on or off.
5. When the call is over, press .

Using the Redial List

The Redial List stores the last ten numbers you dialed. When you press  the last number you called appears on the screen. You can scroll through the list to view the other numbers.



To make a call from the Redial List:

1. Press . The display shows the last number you dialed.
2. Find the number you wish to call by pressing  .
3. When the number is displayed, lift the handset or press either , , or .

Note that if you press  when the Live dial pad option is turned on, after lifting the handset or after pressing , , or , your telephone automatically dials the last number in the Redial list without first displaying it.

There may be times when you want to delete the contents of the Redial List. For example, if you have dialed a personal number such as a password or your calling card number, you may not want it to appear in the list where anyone can see it.

To delete the Redial List:

1. Press .
2. Press  twice. The entire Redial List is deleted.

Call Waiting Identification†

The 9417CW is capable of displaying Call Waiting Identification information of a second incoming call while you have a call in progress. When you are on a call and you hear the Call Waiting tone, the Call Waiting information is displayed as shown below.

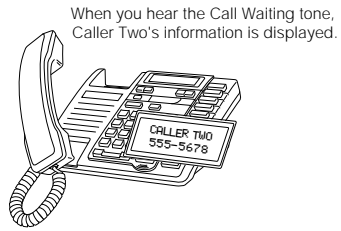
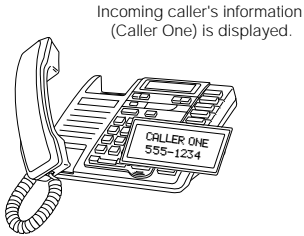

If you decide you want to speak to the new caller, simply press **Link** . Your first call will not be disconnected. You may switch between callers as often as you like by pressing **Link** . When you press **Link** and see a caller's Identification information but only hear a dial tone, it means that the caller has hung up. Your second call will be stored in the Callers List even if it is not answered. For more information about stored calls, see **Callers List** on page 19

Note: The Call Waiting Identification display option must be enabled in order to see the Call Waiting Identification information on the display. Refer to **Turning the display of Call Waiting Identification on or off** on page 12.

Super Call Waiting Identification†

The Super Call Waiting Identification feature allows the 9417CW and one other Super Call Waiting Identification compatible telephone to display identification information about the second call at the same time as shown below.

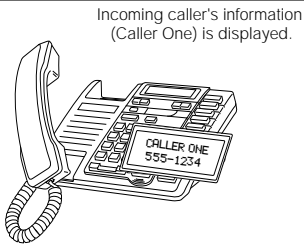

Call Waiting tone sounds and Caller Two's
information is displayed on both extensions.

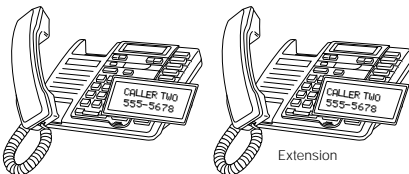

† You must subscribe to your telephone company for the Call Waiting with Calling Line Identification service.

SuperFlash†

The SuperFlash feature allows either of two telephone extensions to activate the link to a Call Waiting call. When a person at either extension presses **Link**, both extensions switch to and speak with the Call Waiting caller as shown in the diagrams below.

Incoming caller's information (Caller One) is displayed.

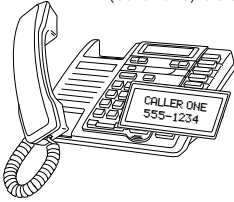

Extension telephone picks up and also speaks with Caller One.

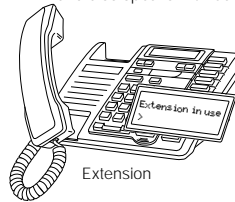

Call Waiting tone sounds and Caller Two's information is displayed on both extensions.

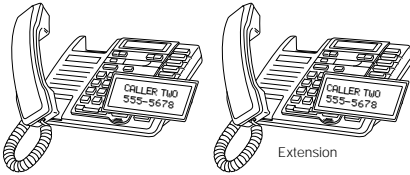

Either telephone can press **Link** to speak with Caller Two.



Both telephones speak to Caller Two and see the displayed information.

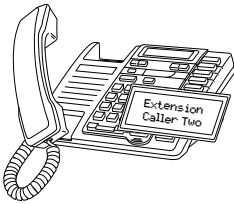

Either telephone can press **Link** again to switch back to Caller One.



Calls will not be disconnected when you press **Link**. If you wish to return to your first caller press **Link** again. The 9417CW and one other SuperFlash-compatible telephone extension will switch between the two callers each time you press **Link**. Once you have switched to one caller by pressing **Link**, you must wait three seconds before you can switch back to the previous caller. When you press **Link** and see a caller's Identification information but only hear a dial tone, it means that the caller has hung up.

To end a call, ensure you can see that call's identification information (you may have to press **Link**), then press **RLS**.

Note: SuperFlash and Super Call Waiting Identification only work with SuperFlash and Super Call Waiting Identification-compatible telephones.

† You must subscribe to your telephone company for the Call Waiting with Calling Line Identification service.

Turning the display of Call Waiting Identification on or off

You can choose whether or not Call Waiting Identification is displayed on your telephone for Line 1 and Line 2.

To turn Call Waiting on or off:

1. Press the Set Options key.
2. Press **✳** to enter the Options list.
3. Use **↓** **↑** to scroll to number 8 or press **8**.
4. Press **8**.
5. Press **Line x**.
6. Press **✳** to turn the Call Waiting Identification feature on or press **#** to turn the feature off.

Note: Turning the display of Call Waiting Identification on or off does not turn the feature itself on or off. When the Call Waiting display is turned off, you will still hear the Call Waiting tone when a Call Waiting call comes in, but the identification information for the Call Waiting caller will not appear on your display screen. Contact your local telephone company to subscribe or unsubscribe to Calling Line Identification with Call Waiting Identification services.

Changing the display language

For changing business requirements, you may wish to change the language of your display messages and prompts.

To change the display language:

1. Press the Set Options key.
2. Press **#** to enter the Setup List.
3. Press **0** or **↓**.
4. Press **0** to select the language indicated.
5. Use **↓** to scroll to the desired language.
6. Press **✳** to select the displayed language.
7. Press **Rls**.

Setting the date and time

If you subscribe to the Calling Line Identification service from your telephone company, the date and time are set automatically after you receive your first incoming call. If you do not subscribe, you must set the date and time manually

To set the date and time:

1. Press the Set Options key.
2. Press **ⓧ** to enter the Options List.
3. Press **↓** or **0**.
4. Press **0** and follow the instructions on the display.
5. Press **RIS**.

To resume the automatic date and time setting (if the date and time has been set manually), disconnect the power supply, then re-connect it. After your first incoming call, the date and time are automatically set if you subscribe to the Calling Line Identification service from your telephone company.

Turning the ringer on and off

To turn the ringer on:

1. Press **◀** **▶**.
2. Press **Line x**.
3. Press the right side of **◀** **▶**. Continue pressing the right hand side until you reach the desired ring volume.
4. Press **Save**.

To turn the ringer off:

1. Press **◀** **▶**.
2. Press **Line x**.
3. Press the left side of **◀** **▶**. Continue pressing the left hand side until the ringer is off.
4. Press **Save**.
Ringer is OFF and the line affected appear on the display.

Note: Do not lift the handset while you are turning the ringer on or off.

Setting the ring tone and ringer volume

You can choose one of four different ring tones and set the ringer volume for each line.

To set the ring tone and volume:

1. Make sure that the ringer is turned on.
2. Press the Set Options key.
3. Press **✕** to enter the Options List.
4. Use **↓** **↑** to scroll to number 1 or press **1**.
5. Press **1** and follow the instructions on the display.
When picking the ring tone, press **◀** **▶** to adjust the volume.
6. Press **Save** to end only when you are satisfied with ring tone and ringer volume.
7. Press **Rls**.

Note: The steps above set the ring tone and volume for one line only. You must repeat these steps to set the ring tone and volume for the other line.

Controlling the ringer volume

While the telephone is ringing on one line, you can press the left or right side of the volume bar **◀** **▶** to adjust the ringer volume for that line.

Controlling the handset volume

While you are on the telephone, you can press the left or right side of the volume bar **◀** **▶** to adjust the handset volume. The handset volume returns to normal after you have completed your call.

Controlling the speaker volume

While you are listening through the speaker, you can press the left or right side of the volume bar **◀** **▶** to adjust the speaker volume. The speaker volume remains at the volume you last selected until the next time you change it.

Changing the prime line

The prime line is the line that is automatically selected when you lift the handset or press **Handsfree Mute** or **Dial**. The default setting for prime line is Line 1. You can select either line as your prime line.

To change the prime line:

1. Press the Set Options key.
2. Press **#** to enter the Setup List.
3. Use **↓** **↑** to scroll to number 5 or press **5**.
4. Press **5** to select the prime line.
5. Press **Rls**.

Directory

The 9417CW stores the numbers and names of up to 100 of your business associates, clients, contacts, and friends in your Directory. You can dial these numbers by selecting them.

Names are sorted alphabetically starting with their first character. (If you want your Directory sorted by the last name, enter the last name first.) If you do not enter a name, the item is sorted by telephone number. The Directory items with only a telephone number are numerically sorted at the beginning of the Directory.

Saving numbers and names to the Directory

To save a new number and name:

1. Press .

2. Press .

3. Enter the number using the dial pad.

4. Press . Only the number is stored at this point.

5. If you do not want a name, go to step 6. To enter a name, use the dial pad. (See **Entering Names** on page 16.)

6. Press .

To save from the display:

1. Ensure that a number is on the display. (For example, access the Redial List, the Callers List, or press a memory key.)

2. Press .

3. Press . If the name is displayed with the number, both are now saved in the Directory.

4. If no name is displayed, you are prompted to enter one. If you do not want a name, go to step 5. To enter a name, use the dial pad. (See **Entering Names** on page 16.)

5. Press .

Saving an active call into the Directory

To save an active call:

1. Answer or make a call.

2. Press .

3. Press . If the name was displayed with the number, both are now saved in the Directory.

4. If no name is displayed, you are prompted to enter one. If you do not want to enter a name, go to step 5. To enter a name, use the dial pad. (See **Entering Names** on page 16.)

5. Press .

6. Press .

Saving a memory key entry to the Directory

To save a memory key entry into the Directory:

1. Press the desired memory key. Ensure the live dial pad option is turned off.
2. Press .
3. Press . If the name was displayed with the number, both are now saved in the Directory.
4. If no name is saved, you are prompted to enter one. If you do not want to enter a name, go to step 5. To enter a name, use the dial pad. (See **Entering Names** on page 16.)
5. Press .
6. Press .

Entering Names

You can program names to correspond with numbers you have entered into the Directory or a memory key. The following paragraphs explain how to enter letters using the dial pad. Before you can use the dial pad to enter names, you must first save or edit a number in the Directory or memory key.

To program a name, find the dial pad key that has the first character of the name. Keep watching the display as you press the key until that character appears on the display. Press a different dial pad key for the next character. If the next character is on the same key, press > to move to the next space. To display upper case letters, press , then press the appropriate dial pad key. To insert a space, press > . To backspace and erase a mistake, press .

For example, to enter the name **Ruth** press these keys:

, , > , , .

If you wish to change a digit or letter after you have entered it, press to erase it.

<input type="text" value="1"/> , - ' & . () 1	<input type="text" value="2"/> a A b B c C 2	<input type="text" value="3"/> d D e E f F 3
<input type="text" value="4"/> g G h H i I 4	<input type="text" value="5"/> j J k K l L 5	<input type="text" value="6"/> m M n N o O 6
<input type="text" value="7"/> p P q Q r R s S 7	<input type="text" value="8"/> t T u U v V 8	<input type="text" value="9"/> w W x X y Y z Z 9
<input type="text" value="*"/> *	<input type="text" value="0"/> 0	<input type="text" value="#"/> #

Making a call from the Directory

To make a call from the Directory:

1. Press .
2. Press or or use the dial pad to find the item you want to dial out.
3. Lift the handset or press either , , or .
4. To end the call, press or hang up.

Note: To leave the Directory at any time, press or . If you're on a call while you are viewing the Directory, pressing also drops the call.

Finding items in the Directory

To find items in the Directory:

1. To see the Directory List heading, press .
 2. To see the listings that start with a particular letter, press the appropriate dial pad key. Then to see the other listings under that letter, press . (For example: takes you to the first "J" listing, then takes you to the next "J" listing. Pressing takes you to the first "K" listing.) Use the letter chart shown under **Entering Names** on page 16.
OR, to move down and up the list, press or . If you want to scroll steadily, press and hold or .
 3. To leave the Directory at any time, press or .
- Note:** If you're on a call while you're viewing the Directory, pressing also drops the call.

Editing in the Directory

To edit a number and/or name in the Directory:

1. Press .
2. Press or to find the item you want to edit.
3. To begin editing, press .
4. If you do not want to change the number, go to step 5. To backspace and erase digits, press . To add digits, use the dial pad.
5. Press .
6. If you do not want to change the name, go to step 7. To change or add to the name, use and the dial pad. (See **Entering Names** on page 16.)
Note: If you edit the wrong item or want to quit without saving changes, press or .
7. Press .
8. Press .

Deleting items from the Directory

To delete individual items:

1. Press .
2. Press to find the item you want to delete.
3. Press twice. You are still in the Directory.
4. Press or to exit the Directory at any time.

To delete all items:

1. Press .
2. Press .
3. Press again to confirm deletion of the entire Directory.
4. Press .

Callers List†

Using the Callers List

The 9417CW stores up to 100 calls in the Callers List. Your telephone logs the number (and name if available) of the caller, when they last called, and the number of times they tried to reach you. See **Callers List display messages** on page 38 for a description of the display messages.

If the telephone number of the incoming call matches a number that you have programmed with a name in a memory key or the Directory, the Callers List shows the name you have saved in the memory key or Directory, and the number.

You can choose to record all of your incoming calls, only unanswered calls, or no calls in the Callers List. Setting the Callers List to record no calls turns the Callers List off.

Setting up the Callers List

The Callers List records up to 100 incoming calls. You can program the telephone to record unanswered calls, all incoming calls, or no calls.

To change the Callers List:

1. Press the Set Options key.
2. Press the **[*]** to enter the Options List.
3. Press **[↓]** four times or press **[4]**.
4. Press **[4]** to change the Callers List.
5. Press **[Line x]**.
6. Press **[↓]** to select **Unanswered**, **All calls**, or **No calls**.
7. Press **[*]**.
Repeat steps 4 through 7 for the other line.

Setting the List Mode

You can program the Callers List to be split by line or combined. If the Callers List is combined, you view the 100 item list at the same time. If the Callers List is split by line, you view the Callers List for each line separately. The Callers List for one line can exceed 50 calls, as long as the list for the other line has less than 50 calls. The total number of calls in the two Callers Lists cannot exceed 100.

To set the List Mode:

1. Press the Set Options key.
2. Press **[*]** to enter the Options List.
3. Use **[↓]** **[↑]** to scroll to number 5 or press **[5]**.
4. Press **[*]** if you want to see the calls for both lines at the same time.
Press **[#]** if you want to see the calls for each line separately.

† You must subscribe to your telephone company for the Calling Line Identification service.

Finding an item in the Callers List

To find items in the Callers List:

1. To see the Callers List heading, press .

 2. Press .
Note: This step is not necessary if the Callers List Mode is set to the combined option. For more information about the Callers List Mode, see **Setting the List Mode** on page 19.

 3. To see the first new caller in the list, press .
To move down and up the list, press .
If you want to scroll steadily, press and hold .
To see the last caller you viewed when you were last in the Callers List, press .

 4. To leave the Callers List at any time, press or .
- Note:** If you're on a call while viewing the Callers List, pressing drops the call.

Making a call from the Callers List

To dial a number in the Callers List:

1. Press .

 2. Press .
- Note:** This step is not necessary if the Callers List Mode is set to the combined option. For more information about the Callers List Mode, see **Setting the List Mode** on page 20.
3. Find the item you want to dial out.

 4. Lift the handset or press either , , or .

 5. To end the call, press or hang up.

If you call a number from the Callers List and you don't get connected, you may have to edit the number (for example, the number may be long distance and you may have to add "1"). See the **Editing in the Callers List** on page 21.

Editing in the Callers List

To edit a number in the Callers List:

1. Press .
2. Press .
Note: This step is not necessary if the Callers List Mode is set to the combined option. For more information about the Caller List Mode, see **Setting the List Mode** on page 19.
3. Find the item you want to edit.
4. Press any key on the dial pad to begin editing. This may be required if you have tried to dial the number and there is no connection.
5. To add digits, use the dial pad. To erase one digit to the right of the cursor, press . To erase one digit to the left of the cursor, press .
6. To dial the edited number, lift the handset or press either or , or .

To have the Callers List show local numbers without the area code and internal numbers as extensions, see **Entering area codes** on page 30.

To dial back a long distance number in the Callers List:

1. Press .
2. Use to find the item you want to edit.
3. Using the dial pad, press and the area code if necessary.
4. To dial the edited number, lift the handset or press either or .
5. If you want to save the number to the directory, press . See **Saving numbers and names to the Directory** on page 15.

Saving Callers List numbers to the Directory or a Memory key

To copy a number from the Callers List to the Directory or to a memory key:

1. Press .
2. Press .
3. Find the item you want to copy.
4. Press .
5. Press or the memory key where you want to store the number.
6. If no name is displayed, you are prompted to enter one. To enter a name, use the dial pad. (See **Entering Names** on page 16.) If you don't want a name, go to step 7.
7. Press .
8. To leave the Callers List at any time, press or .

Deleting from the Callers List

To delete a number in the Callers List:

1. Press .
2. Press .
Note: This step is not necessary if the Callers List Mode is set to the combined option. For more information about the Callers List Mode, see **Setting the List Mode** on page 19.
3. Find the item you want to delete.
4. Press twice.
You are still in the Callers List.
5. To leave the Callers List at any time, press or .

To delete all numbers in the Callers List:

1. Press .
2. Press .
Note: This step is not necessary if the Callers List Mode is set to the combined option. For more information about the Callers List Mode, see **Setting the List Mode** on page 19.
3. Press twice while the Callers header is showing to delete the entire list.

Memory keys

Saving numbers and names into memory keys

You can save the numbers and names of your customers, business associates, or anyone you call frequently in 9417CW's six memory keys. You can store more numbers and names in the Directory. See the **Directory** section on page 15 for more information.

To save a number and name:

1. Press .
2. Press the memory key where you want to save the number.
3. Enter the number using the dial pad. You can enter a maximum of 24 digits.
Note: If you require a pause (for example, between a telephone number and an access code), press where you want the pause.
4. Press .
5. To skip the name, go to step 6. To enter a name, use the dial pad.
(See **Entering Names** on page 16.)
6. Press .
7. Label the memory key. (See the diagram on page 23.)

Saving from the display into memory keys

To save from the display:

1. Ensure that a number is on the display. (For example, access the Redial List or Callers List.)
2. Press .
3. Press the desired memory key. If the name was displayed with the number, both are now saved in the memory key and you're finished.
4. If no name is displayed, you are prompted to enter one. If you don't want a name, go to step 5. To enter a name, use the dial pad. (See **Entering Names** on page 16.)
5. Press .
6. Label the memory key. (See the diagram on page 23.)

Saving an active call into a memory key

To save an active call:

1. Answer or make a call.
2. Press .
3. Press the desired memory key. If the name was displayed with the number, both are now saved in the memory key.
Note: Do not press or else you will hang up on your caller.

Labeling the memory keys

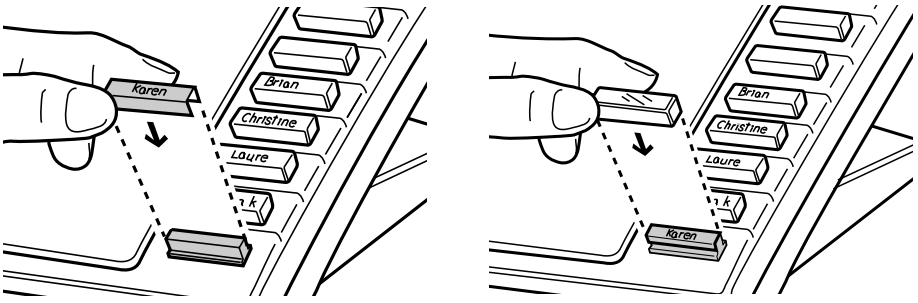

After programming the memory keys, label them with the supplied blank labels and key caps.[†]

[†] Keep keys caps and the sliding panel away from small children. These small parts may come off the telephone if it is dropped.

Making calls from memory keys

To call from a memory key:

1. Lift the handset or press .
 or .
2. Press the memory key with the number you want to dial out.

To predial from a memory key:

1. Press the memory key with the number you want to dial out.
2. Lift the handset or press either , , or .

Note: If the Live dial pad option is turned on, you do not have to lift the handset or press any other button. Pressing the memory key will automatically dial the number and put the telephone in Handsfree mode.

Editing memory keys

To edit a memory key:

1. To see its contents, press the memory key.
2. Press .
3. If you don't want to change the number, go to step 4. To backspace and erase digits, press . To add digits, use the dial pad.
4. Press .
5. If you don't want to change the name, go to step 6. To add letters, use the dial pad. (See **Entering Names** on page 16.) To erase letters, press .
6. Press .

Note: The Live dial pad option must be turned off to edit memory keys. See **Selecting the dial pad mode** on page 30.

Deleting memory keys

To delete a memory key:

1. To see its contents, press the memory key.
2. To erase, press twice.

Note: The Live dial pad option must be turned off to edit memory keys. See **Selecting the dial pad mode** on page 30.

Saving features in memory keys[†]

For easy access, you can save the feature codes of telephone company services in your memory keys. This works well with network features such as Call Forwarding and Call Return. Some features require an On and Off code in two separate keys, while other features are stored on only one key. The following procedures show you how to save both an On and Off code.

To save a Feature On code:

1. Press .
 2. Press the memory key where you want to save the number.
 3. Enter the telephone company feature code for turning the feature on.[†]
- Read the display to confirm the number.
4. Press .
 5. Enter the feature name using the dial pad. (See **Entering Names** on page 16.)
 6. Press .
 7. Label the memory key.

To save a Feature Off code:

1. Press .
 2. Press the memory key where you want to save the number.
 3. Enter the telephone company feature code for turning the feature off.[†]
- Read the display to confirm the number.
4. Press .
 5. Enter the feature name using the dial pad. (See **Entering Names** on page 16.)
 6. Press .
 7. Label the memory key.

[†]**Note:** Contact your telephone company for the appropriate feature codes.

Using feature keys

When a memory key is programmed with a feature code, you can use the memory key to activate or deactivate the feature.

To turn a feature on or off:

1. Press the memory key where you stored the desired feature. The display shows the feature name and code.
2. Lift the handset or press either , , or . The feature code is dialed out, which turns the feature on or off.

The active feature applies only to the line you selected or to the prime line if you did not press a line key. For example, if you want to forward all incoming calls, you must turn the feature on for each line.

Note: If the Live dial pad option is turned on, you do not have to lift the handset or press any other button. Pressing the memory key will automatically dial the feature code and put the telephone in Handsfree mode.

Saving a feature and light in memory keys

You can make the set indicator light come on when you turn a feature on and go off when you turn that same feature off. You can only do this with one feature, and the feature must have separate On and Off codes (such as Call Forwarding).

[†] You must subscribe to your telephone company for Custom Calling Features.

For example, you may want the light to remind you that you have turned Call Forwarding on. To do this, use one key to turn the indicator light on when you activate the feature. Use the second key to turn the indicator light off when you deactivate that same feature. The following procedure shows you how to program a FeatureLight On and Off key.

To save a FeatureLight On key:

1. Press .
2. Do NOT select a memory key yet. To program the light on, press .
3. Press the desired memory key.
4. Enter the telephone company feature code for turning the feature on.[†]

Read the display to confirm the number.

5. Press .
6. Label the memory key.
(See the diagram on page 23.)

To save a FeatureLight Off key:

1. Press .
2. Do NOT select a memory key yet. To program the light off, press .
3. Press the desired memory key.
4. Enter the telephone company feature code for turning the feature off.[†]

Read the display to confirm the number.

5. Press .
6. Label the memory key.
(See the diagram on page 23.)

[†]**Note:** Contact your telephone company for the appropriate feature codes.

Using FeatureLight keys

To turn a feature and light on or off:

1. Press the memory key where you stored the FeatureLight. The display shows **FeatureLight ON** or **FeatureLight OFF**.
2. Lift the handset or press either , , or . The feature and light turn on or off. (When the feature and light are on and you're not using the telephone, the display shows **Feature ON** and the line that it applies to as a reminder.)

Advanced Features

Adding a timer key

You can program any of the memory keys to be a timer key. The timer key contains a separate timer for each line

To add a timer key:

1. Press the Set Options key.
2. Press **#** to enter the Setup List.
3. Use **↓** **↑** to scroll to number 6 or press **6**.
4. Press **6** to add a Timer key.
5. Press a memory key.
6. Press **Save**.
7. Label the timer key. (See the diagram on page 23.)
8. Press **Rls**.

Using the Call Timer

The timer key is used to time the length of a call. The timer key contains a separate timer for each line.

To show the timer on the display:

1. Make or answer a call. The timer starts running automatically.
2. Once on the call, press the timer key.
The display shows the running time of the calls on either or both lines.
3. To return to the call information display, press the timer key again.
4. When the call is over, hang up the handset or press **Rls**. The timer stops counting.

Note: To show the elapsed time of the most recent call (or last call) on each line when you're not on a call, press the timer key.

Deleting a timer key

To delete a timer key

1. Press the timer key.
2. Press **Delete** twice.

Adding a page key

You can program any of the memory keys to be a page key. If the page key is assigned, the 9417CW is able to receive and initiate page transmissions.

To add a page key:

1. Press the Set Options key.
2. Press **#** to enter the Setup List.
3. Use **↓** **↑** to scroll to number 7 or press **7**.
4. Press **7** to add a page key.
5. Press a memory key.
6. Press **Save**.
7. Label the page key. (See the diagram on page 23.)

Note: For proper operation of the Page feature, all telephones must have Page keys assigned.

Using the page

The page feature of the 9417CW allows you to send a page message to other 9417CW telephones, to an external speaker within your office, or to other page-compatible Aastra telephones (such as the 9516CW). Before you can use this feature, you must program one memory key on each telephone in the paging network to be the page key. Also, page lines must be connected between all of the telephones. See **Installing the Page Lines** on page 29 for more information on connecting the page lines.

To send a page message:

1. Lift the handset.
2. Press the page key and speak into the handset.
3. Replace the handset or press **RLS** to end a page.

Deleting a page key

To delete a page key, you must first reprogram the key to be a memory key. You can then delete the memory key.

To delete a page key:

First, reprogram the key to be a memory key:

1. Press .
2. Press the page key.
3. Press to begin re-programming the page key to be a memory key.
4. Press two times to skip the number and name prompts. The page key has been changed to a memory key.

Second, clear the contents of the memory key:

5. Press the page key.
6. Press twice.

Note: The Live dial pad option must be turned off to delete a page key. To save a number into the memory key, refer to **Memory Keys** on page 22.

Installing the page lines

The page lines must be connected in parallel with each other on pins 1 and 6 of jack 2 as shown below.

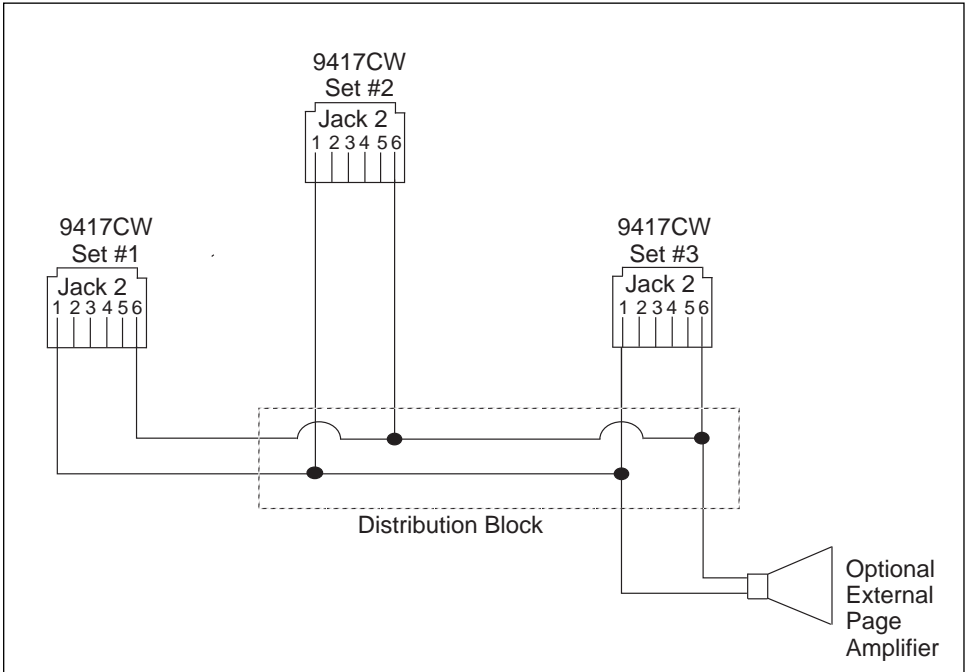

Note: A 6 conductor line cord is required to connect page lines. This cable is not supplied with the 9417CW telephone. Contact your telephone company to have page lines connected to your telephones.

Selecting the dial pad mode

When you select the dial pad mode, you are turning the Live dial pad option on or off. With Live dial pad on, the telephone chooses the prime line and automatically dials out and turns on Handsfree as soon as you press a dial pad key or a memory key. When Live dial pad is off, the telephone is in predial mode. This means after you dial the telephone number you must lift the handset or press either , , or before the telephone number is dialed.

To select the dial pad mode:

1. Press the Set Options key.
2. Press to enter the Option List.
3. Use to scroll to number 2 or press .
4. Press to change the dial pad mode.
5. Press .

Entering area codes

When you enter an area code or prefix using this feature, your 9417CW telephone will remove that code or prefix from incoming numbers. For example, if you enter your area code into this option, all calls in your area code will appear in the Callers List with the area code stripped off (the area code will appear in brackets after the number). This may make it easier to identify local calls. You can enter three separate area codes or prefixes, each up to seven digits long.

To enter area codes and prefixes:

1. Press the Set Options key.
2. Press to enter the Setup List.
3. Use to scroll to number 3 or press .
4. Press .
5. Enter the area code or prefix using the dialpad and press . Repeat these steps 4 and 5 for each area code or prefix you want to enter.

To delete or edit an area code or prefix:

1. Press the Set Options key.
2. Press to enter the Setup List.
3. Use to scroll to number 3 or press to go directly to the item.
4. Press . The first area code is displayed. If this is the number you want to delete or change, go to step 6.
5. Press until you see the number you want to change or delete
6. Press to backspace and delete, or change the area code or prefix.
7. Press .
8. Press .

Entering Dialing Restrictions

Dialing Restrictions are used to prevent certain numbers from being dialed out. There are three 7-digit codes that can be programmed to prevent certain numbers from being dialed. If you attempt to dial a number that matches the restricted digits, the message **Restricted number** appears on the display. For example, if you entered the codes below:

- 1st code> 0
- 2nd code>1
- 3rd code> 411

Any number beginning with 0, 1 or 411 could not be dialed from the telephone. However, the number 555-0411 could be dialed because it does not begin with the restricted digits.

To enter Dialing Restrictions:

1. Press the Set Options key.
2. Press **#** to enter the Setup List.
3. Use **↓** **↑** to scroll to number 2 or press **2**.
4. Press **2**.
5. Enter the digits you want restricted and press **Save**. Repeat this step for each dialing restriction you want to enter.
6. Press **RLS**.

To delete or edit Dialing Restrictions:

1. Press the Set Options key.
2. Press **#** to enter the Setup List.
3. Use **↓** **↑** to scroll to number 2 or press **2**.
4. Press **2**.
5. Press **←** to back space and delete or change restricted digits.
6. Press **Save**. Repeat steps 5 and 6 for the restricted digits that you want to delete.
7. Press **RLS**.

Important: Care must be taken when you are restricting numbers that start with 9. If you enter 9, 91, or 911 as one of the dialing restrictions, you will not be able to dial the emergency services number 911.

The Security Numbers Feature

The 9417CW is equipped with a Security Numbers feature to keep selected numbers private when you dial. When you have entered a security number using this option, your telephone does not display or store the digits that you dial after that security number. Instead, the numbers that follow the security number are replaced with the * symbol on the display. You can secure up to five 24-digit numbers.

For example, Joe enters 291-9000 as a security number through the Set Options list. His Voice Mail number is 1234 and his password is 5678. To access his messages, Joe dials 291-9000 1234 5678. Because the Voice Mail number and password follow the security number, the display shows 291-9000 *****, and Joe's password is not displayed or stored in the Redial List. For more information on the Redial List, refer to **Using the Redial List** on page 9.

To enter a security number:

1. Press the Set options key.
2. Press **#** to enter the Setup List.
3. Use **↓** **↑** to scroll to number 8 or press **8**.
4. Press **8**.
5. Using the dial pad, enter the secure number.
6. Press **Save** to end.
7. Repeat steps 5 and 6 for each secure number you want to enter.
8. Press **RLs**.

To delete or edit a security number:

1. Press the Set options key.
2. Press **#** to enter the Setup List.
3. Use **↓** **↑** to scroll to number 8 or press **8**.
4. Press **8**.
5. Press **Save** until you find the number you want to change or delete.
6. Press **←** to backspace and simply delete the secure number, or delete the secure number and use the dial pad to enter the changed number.
7. Press **Save**.
8. Press **RLs**.

The Fax Switch

The Fax Switch feature allows you to have three telephone numbers on two incoming lines. There is one telephone number for each of the lines and another telephone number for a Fax Switch peripheral (e.g. fax machine, answering machine etc.).

To use the Fax Switch, you must subscribe to your telephone company for Distinctive Ringing[†] on Line 2. The telephone company will then provide you with a telephone number (for your Fax Switch peripheral) which will ring on Line 2 with a slightly different ring tone. The 9417CW will use the two ring types to determine whether an incoming call is for the telephone or the peripheral. The peripheral should be set to answer after three or more rings.

Note: If Long Distance Ringing[†] is available in your area, the long distance call will be sent to the Fax Switch peripheral.

The 9417CW must be configured so that Line 1 and Line 2 are both connected through jack number 1 and the Fax Switch peripheral is connected to pins 3 and 4 of jack number 2. See **Basic Installation**, on page 2 for more information.

Note: If Line 2 of your 9417CW telephone has Call Waiting enabled, your Fax Switch peripheral may lose data or be disconnected if someone else calls Line 2. We recommend that you do not use Call Waiting on Line 2 if you are using the Fax Switch feature.

Incoming Calls

The first ring of an incoming call will ring at the 9417CW and the Fax Switch peripheral. The 9417CW uses this ring to identify which device the call is intended for. If it is a normal ring, the call is routed to the 9417CW and the Fax Switch peripheral stops ringing and is disconnected. If it is a distinctive ring, the call is rerouted to the Fax Switch peripheral and the 9417CW stops ringing.

Outgoing Calls

When the Fax Switch peripheral is idle, Line 2 of the 9417CW terminal can be used as a normal line. When the Fax Switch peripheral is in use, the Line 2 indicator light is on.

Setting the Fax Switch

You can program the telephone to enable or disable the Fax Switch feature.

To set the Fax Switch:

1. Press the Set Options key.
2. Press **✖** to enter the Options List.
3. Use **↓** **↑** to scroll to number 6, or press **6**.
4. Press **6** to enable or disable the Fax Switch.

Note: For proper operation of the Fax Switch feature, all of the 9417CW telephones connected to Line 2 must have the Fax Switch enabled.

[†] The actual name for the Distinctive Ringing service varies from area to area. This service may also be known as *Ident-a-call*, *Ident-a-ring*, *Teen Service*, *Signal Ring*, *Custom Ringing* or *Long Distance Ringing*.

Copying the Directory to another 9417CW telephone

The contents of the Directory of one 9417CW telephone can be copied into the Directory of another 9417CW. You can save a lot of programming time by copying the contents of a completed Directory to another Directory instead of entering the names and numbers again. The contents of the Directory can also be transferred into any other Aastra telephone that supports Directory transfer. (For example, the 9516CW).

While the Directory is being transferred, both Lines 1 and 2 are out of service.

Note: Both 9417CW telephones must have separate telephone numbers.

To copy the Directory to another 9417CW telephone:

Steps 1 to 4 must be completed on both 9417CW telephones.

1. Press the Set Options key.
2. Press **☒** to enter the Options List.
3. Use **↓** **↑** to scroll to number 7 or press **7**.
4. Press **7** to begin the Directory Transfer.
5. On the 9417CW telephone you are copying the Directory from, press **Line 1** and dial the telephone number of Line 2 of the other 9417CW. The display shows a message indicating that the Directory information is being sent. **Note:** The handset must remain in the cradle while the Directory is being transferred. During the transfer, press the left side of **◀** **▶** to turn down the volume.
6. The display shows: **Data transfer complete** when the Directory Transfer is complete. If the transfer is unsuccessful, the display shows: **Data transfer aborted**.

Note: To end the Directory Transfer at any time, press **Rls**.

If the Directory on the telephone receiving information fills before the Directory Transfer is finished, the rest of the Directory items are not sent. For example, if the telephone receiving information already has 25 items in its directory, only the first 75 Directory items are transferred from the other telephone.

Note: If you subscribe to the Call Waiting service from your telephone company and someone calls while the Directory Transfer is in progress, the transfer may be corrupted by the Call Waiting tone.

Using a headset

To connect the headset, you must disconnect the handset and attach the headset to the jack labeled .

You cannot use Handsfree when the headset mode is enabled. The **Handsfree Mode** key is used to answer the call or to select the prime line when you are making a call. Press **Rls** when the call is finished.

Note: When the headset mode is enabled, the handset must remain in the cradle. The headset mode default is off.

To change the headset mode:

1. Press the Set Options key.
2. Press the **#** to enter the Setup List.
3. Use **↓** **↑** to scroll to number 1, or press **1**.
4. Press **1** to change the headset mode from enabled to disabled or disabled to enabled.

We suggest contacting the manufacturers Brock Telecom, UNEX, ACS Communications or Plantronics for compatible headsets/amplifiers.

Selecting the answer mode

When you select the answer mode, you are choosing which line is answered when both lines are ringing and you lift the handset or press **Handsfree Mute**.

Select **Ans. Prime** (factory setting), if you want the telephone to automatically answer the prime line first when both lines are ringing and you lift the handset or press **Handsfree Mute**. Refer to **Changing the prime line** on page 14 for information on how to choose which line is the prime line.

Select **Ans. longest**, if you want the telephone to automatically answer the line that began ringing first when both lines are ringing and you lift the handset or press **Handsfree Mute**.

To select the answer mode:

1. Press the Set Options key.
2. Press **#** to enter the Setup List.
3. Use **↓** **↑** to scroll to number 4 or press **4**.
4. Press **4** to change the answer mode.
5. Press **#** to choose the Prime line, or ***** to choose to answer the longest ringing line.
6. Press **Ans**.

Extension in use

When you lift the handset or press **Handsfree Mute**, the 9417CW telephone automatically selects the prime line. If your prime line is Line 2 and the peripheral device (e.g. fax machine) is using that line, the line is not selected and the message **Extension in use** appears on the first line of the display and Press line key appears on the second line of the display. If you press **Line 1**, you access Line 1 and can make a call. If you press **Line 2**, you will access Line 2 and may interrupt the call to the peripheral.

Display messages and lights

The 9417CW has a backlit three-line display that uses icons and messages for your call information as shown below.

The Callers List screen

A sample Callers List screen is shown below.

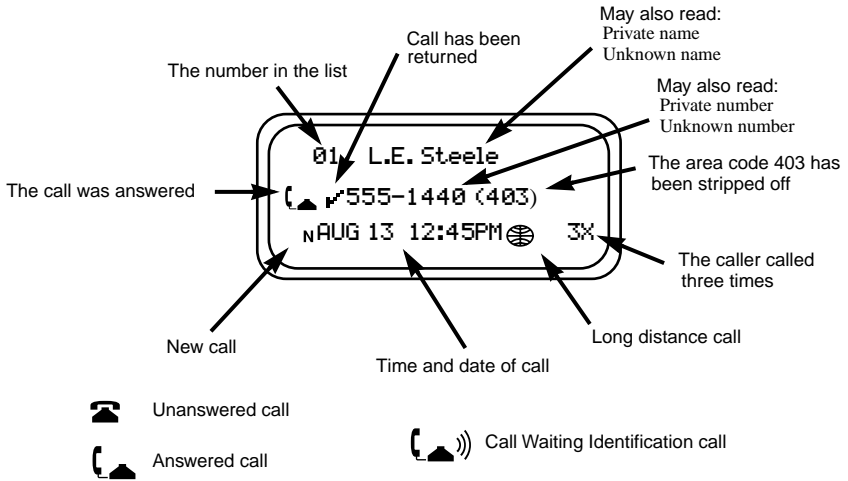

Knowing when you have a message

9417CW's set indicator light lets you know that your Voice Mail system has a message for you. The set indicator light flashes slowly and the display shows

Message Waiting
Line x

or

Message Waiting
Line 1 Line 2

after your Voice Mail has received a call. Contact your local 3X telephone company to find out how you can subscribe to Voice Mail services.

Clear Message Waiting

There may be times when **Message Waiting** appears on the display when there are no more Voice Mail messages. You can turn the display message off using the Clear Message Waiting feature.

To clear message waiting:

1. Press the Set Options key.
2. Press the **[*]** to enter the Options List.
3. Use **[↓]** **[↑]** to scroll to number 3 or press **[3]**.
4. Press **[3]** to clear message waiting.
5. Select **[Line x]**.
If required, repeat steps 4 and 5 for the other line.

Note: This only applies when you subscribe to Voice Mail services from your telephone company.

Clear the Check Line Cord Message



There may be times when check line cord appears on the display and you want to clear this message. For example, you may have moved the 9417CW to another jack and have only connected one line cord. You can remove the check line cord message through the Set Options List.

To clear the check line cord message:



1. Press the Set Options key.
2. Press the **#** to enter the Setup List.
3. Use **↓** **↑** to scroll to number 9 or press **9**.
4. Press **9**.
5. Select **Line x**.
6. Press ***** to enable the check line cord message. Press **#** to disable the check line cord message.



General display messages

Message	What it means
Check line cord	If there is no dial tone, make sure the line cord and handset cord are attached securely.
Data transfer	The transfer of Directory information from one 9417CW to another 9417CW has begun.
Data transfer aborted	The transfer of Directory information has been aborted.
Directory empty Use SAVE to add	The Directory remains empty until you add numbers and names to it.
Directory full No changes made	The Directory has a 100 entry limit. If you want to add an item, delete an item you no longer use.
Extension in use	An extension telephone is using the same line that you want to use. Select the other line instead. Or, someone is trying to use the same line on an extension telephone.
Feature ON	The FeatureLight On key has been pressed and the code dialed out. To turn off the feature and the light, press the FeatureLight Off key and lift the handset or press either Handsfree Mute , Dial _____ , or Line x _____ .
<Forwarded Call	The call is forwarded from another telephone.
Key is locked	The memory key is factory-programmed and cannot be erased or reprogrammed. Program a different memory key.
	The caller is calling from outside your local area.
Make calls first or Make second call	You must make two calls before you press Conference .
Message Waiting Line x	Your Voice Mail service has received a call for you. To subscribe to Voice Mail service contact your telephone company.
Press Conference	Both calls of a Conference are on hold. Press Conference to re-establish the Conference.

Message	What it means
Press line key	This appears when the call you want is on hold. You must press Line x to retrieve the held call.
Private number or Private name	The caller has requested that the telephone company not deliver the number or name.
Redial list is empty	This appears if you press Redial before making any calls on your telephone or if power has been interrupted.
Restricted number	The number you have entered cannot be dialed because it has been entered into the Dialing Restrictions feature.
Ringer is OFF Line x	The ringer volume is turned off for that line. Without lifting the handset, press the volume bar.
Unknown name or Unknown number	The name or number is unavailable from the telephone company.
>...xxxxxxxxxxxxxxxx ...xxxxxxxxxxxxxxxx	The telephone number is longer than the display. The display shows ... and the last 15 or 16 digits of the number.
XX New Callers	When you're not on the telephone and not in the Callers List, the display shows you how many callers have been added to the list since you last checked it.
	Indicates an incoming call.
	Indicates that the phone is off hook.
	Indicates an incoming Call Waiting call.

Callers List display messages

Message	What it means
Callers List is empty	Your telephone does not record incoming calls until you subscribe to Calling Line Identification service. If you do subscribe, you haven't received any calls in the list yet or you've deleted all numbers in the Callers List.
Calls bumped=xx	xx is the number of old calls automatically removed to make room for incoming new calls in the Callers List. The limit is 100 calls.
<Forwarded	The call is forwarded from another location.
	The caller has called from outside your local area. Long distance dialing is required to return the call.
No number	You are trying to call someone in your Callers List and the number is unknown or private.
Private number or Private name	The caller has requested that the telephone company not deliver the number or name.
Unknown name or Unknown number	The name or number is unavailable from the telephone company.
✓555-1449 (403)	✓ means you have returned the call from the Callers List.
N MAR04 3:30PM 2x	N means a new call.
...xxxxxxxxxxxxxxxx	... means the number is longer than the display.
	Indicates an unanswered call in the Callers List

Message	What it means
	Indicates an answered call in the Callers List
	Indicates a Call Waiting call in the Callers List
R Smith 123-456-7890 MAR 04 3:30PM 2x	2x means this caller has called twice. The display shows the date and time of the last call from that caller.

Learning about the lights

The set indicator light also alerts you when another extension is on the same line you're using, the telephone rings, or a feature is on. There are also indicator lights beside the line keys and  to show you the status of the lines and of Handsfree and Mute.

Set indicator light messages



Feature	Light
Extension in use	Set indicator light is on. The appropriate line indicator light is on.
Feature ON	Set indicator light is on.
Message Waiting [†]	Set indicator light flashes slowly.
Ringer is OFF	Set indicator light is off.
Visual Ringing	Set indicator light flashes very quickly.

[†]You must subscribe to Voice Mail services from your telephone company for this feature to work.

Line and Handsfree indicator light messages

Feature	Light
Call is ringing on a line	Line indicator light flashes very quickly.
Call is on hold	Line indicator light flashes quickly.
Call is on Handsfree	Handsfree/Mute indicator and line indicator light are on.
Line is in use	Line indicator light is on.
Microphone is muted	Handsfree/Mute indicator light flashes quickly.

Viewing multiple display and light messages

When you aren't using the telephone, there are several messages that can be active at any time, such as date and time, **X New Callers**, **Feature ON**, **Message Waiting**, and **Ringer is OFF**. When more than one of these messages is active, the display shows the most recent message and an arrow beside it (e.g., **1 New Caller →**). You can view the other messages by pressing . Each time you press , the display shows the next active message and its associated light.

Troubleshooting

The display is in the alternate language.

You can change to the other language by pressing the Set Options key and #, then pressing 0 twice.

The cursor doesn't move when saving in the Directory.

The number or name is too long. Numbers can be no longer than 24 digits and names can be no longer than 16 characters.

There is no information on the display and the ringer volume is low.

Make sure the power adaptor is plugged in to a working electrical outlet.

I cannot hear a caller.

Make sure the handset cord is inserted securely into the jack and make sure the receiver volume is high enough.

I answer the telephone and only hear the dial tone.

The call is on your non-prime line; press the line key with the flashing light to answer the call. If this happens often, change your answer mode to Longest or change your prime line.

The power is out and the display is blank.

9417CW still operates as a regular telephone during a power failure. You can dial using the dial pad and you can receive calls, but the other keys and the display do not operate until the power is restored. Only Line 1 works in this situation.

The display works but you can't hear dial tone.

Your telephone lines may be wired differently from the telephone jack. To have a service person correct the wiring, contact your local telephone company.

Also check to ensure that the Headset mode is disabled.

The telephone wobbles.

Check that the handset cord is placed in the channel between the stand and the telephone. See the illustration on page 4.

I cannot program a memory key.

Some of the memory keys may be factory-programmed. These keys are locked and cannot be erased or reprogrammed.

Callers are not identified on the display.

Let the telephone ring at least twice before answering. If that doesn't work, you may not have a Calling Line Identification[†] service. To subscribe, contact your local telephone company.

[†] This service may have a different name in your area. Contact your telephone company for information.

The Callers List is empty.

Until you subscribe to Calling Line Identification[†] service, your telephone does not record incoming calls. Also, the Call Log option may be set to log no calls. See page 19 for information.

I cannot dial a number in the Callers List.

The caller may have an unknown number.

The telephone hisses while not in use.

The page feature has been activated, but the page lines have not been connected to the telephone. Delete the page key.

How do I connect my fax to work with this phone?

To set up a fax machine to work with the M9417CW, you must first subscribe to a Distinct Ring[†] service for line 2 through your telephone company. Connect the fax to the M9417CW jack marked 2 . Next, set the fax machine to pick up after at least three rings (consult the fax machine manual for details). Finally, enable the fax switch option (option 6) on the M9417CW. For more details, refer to **Connecting an optional fax machine or modem** on page 5 and **The Fax Switch** on page 33.

When the Fax switch feature is enabled, the message “Extension in use” appears for Line 2 and Line 2 is not being used.

Make sure that the fax machine, or other Fax Switch peripheral, is connected to jack 2 of the 9417CW telephone. For the Fax Switch feature to operate properly, the telephone line (containing both line 1 and line 2) must be connected to jack 1 of the 9417CW and the Fax Switch peripheral must be connected to jack 2 of the 9417CW. The Fax Switch peripheral should not be connected to the telephone line directly (i.e. connected to the socket on the wall).

The speakerphone is not working.

If the speakerphone is not working, the option for the headset may be enabled. To fix this problem, go to option 1 in the set up list and turn the option off.

I have only one line connected to my phone, and I keep getting the message Check line cord.

You may disable this prompt via option 9 under the Setup List. Also check that the line cord is connected to a jack.

How do I set up paging on this phone?

You can connect up to four phones or external speakers to a paging loop with the M9417CW. Each phone in the paging loop must be connected via pins 1 and 6 of Jack 2, which requires a 6 conductor line cord. Contact your local telephone company to have to have the page lines connected. For a detailed diagram, refer to **Installing the page lines** on page 29.

[†] This service may have a different name in your area. Contact your telephone company for information.

The light is stuck on, and the message feature on is displaying.

A Feature Light On code has been entered, and you need to program a Feature Light Off key. Follow the steps that appear in **Using FeatureLight keys** on page 26.

Live dialpad has stopped working.

It may be that the Live Dialpad option has been turned off in the Options List. Option 2 should be on. If this does not solve the problem, disconnect and then reconnect the AC adapter.

The display is blank on my phone.

Check that the power adapter is connected to the phone, and that the phone is connected to a working outlet. You can test the outlet with another device, such as a lamp.

How do I answer Call Waiting?

To answer a Call Waiting call, press . You may have to subscribe to a Call Waiting[†] service to use this feature.

I can view regular Caller ID information, so why can I not see who is calling on Call Waiting?

Ensure that the Call Waiting Identification option (option 8) is on, and that you have subscribed to a Call Waiting ID[†] service from your telephone company. Also note that you will not receive Call Waiting ID when an extension is in use.

[†] This service may have a different name in your area. Contact your telephone company for information.

Index

A

- Answer mode 35
 - answer longest 35
 - answer prime 35
 - selecting 35

Area codes 30

C

- Call Display
 - see Calling Line Identification
- Call Waiting Identification 10
 - turning display on/off 12
- Call Waiting tone
 - see Call Waiting Identification
- Callers List
 - deleting in 22
 - dialing long distance 21
 - display messages 38
 - editing 21
 - finding items 20
 - making a call 20
 - saving to the Directory or a memory key 21

Calling

- from a memory key 24
 - from the Callers List 20
 - from the Directory 17
 - from the Redial List 9
- Calling Line Identification 1, 7, 10, 11, 12, 13, 19, 38, 40

Calls

- answering 7
- Call Waiting 10
- conferencing 8
- handsfree 8
- holding 7
- making from the Redial List 9
- muting 9
- switching between lines 8

Clear Message Waiting 36

CLID

- see Calling Line Identification 10

Conference call 8

making 8

Connecting

- fax or modem 5
- handset cord 4
- line cord 4
- power adaptor 4

Contrast key 2

Cords

- see Connecting

D

Date and time 13

automatic 13

setting 13

Deleting

- a timer key 27
- area codes 30
- dialing restrictions 31
- Directory items 18
- items in the Callers List 22
- memory keys 24
- page key 29
- Redial List 9
- security number 32
- the Page key 29

Dial pad 30

- entering names 16
- selecting the mode 30

Dialing

- long distance 21
- Restrictions 31

Directory 15

- deleting items 18
- editing 17
- entering names 16
- finding items 17
- making a call 17
- saving numbers and names 15
- transfer 34

Display

- language
 - changing 12
- messages 37
 - Callers List 38
 - general 37

E

Editing

- area codes 30
- dialing restrictions 31
- memory keys 24
- security numbers 32
- the Callers List 21
- the Directory 17

F

Fax Switch 33

Index

Feature Light keys 26

Flash

see Link, SuperFlash

H

Handsfree 8

Handsfree/Mute key 3

Helpful hints

see Troubleshooting 40

Hold 7

automatic 8

I

Installation 4

K

Key descriptions 2

L

Language

see Display language 12

Left arrow key 2

Letters

entering 16

Lights

set indicator light messages 39

Link

Call Waiting Identification 11

SuperFlash 11

Link key 3

Live dial pad

see Dial pad 30

Long distance 21

M

Memory keys 22

cannot program 40

deleting 24

editing 24

labeling 23

making calls from 24

predialing from 24

saving Feature/light to 25

saving features 25

saving from the display 23

saving numbers and names 22

Message Waiting 39

Messages

see Voice Mail

Mute 9

N

Names

entering 16

O

Options List 3

P

Page key 28

connecting the page lines 29

Prime line 14

answering 35

changing 14

selecting 35

R

Redial

key 3

List 9

Right arrow key 2

Ring tone, setting 14

S

Save key 2

Saving

a memory key to the Directory 16

feature codes to memory keys 25

Feature Light to memory keys 25

from Callers List

to Directory or memory key 21

from the display

to a memory key 23

to memory keys 23

to the Directory 15

names and numbers

to memory keys 22

to the Directory 15

Scroll key 2

Security numbers feature 32

Set indicator light messages 39

Setting

date and time 13

ring tone and volume 14

Setup List 3

SuperFlash 11

Switching between lines 8

T

Timer key 27

adding 27

deleting 27

using 27

Troubleshooting 40

Index

V

Voice Mail 32, 36, 37, 39

Volume 14

- handset 14

- key 3

- muting a handsfree call 9

- ringer 14

- speaker 14

- turning the ringer on and off 13

GENERAL INQUIRIES

If you have read the guide and you still have questions, call 1-800-574-1611 in Canada and the USA. In other areas, contact your telephone company.